

### Infrared Receiver Module IRM-H6XXT/TR2 Series

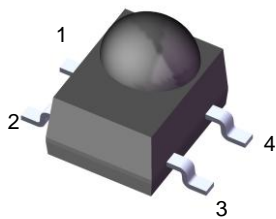

Pin Configuration

- 1. GND
- 2. GND
- 3. OUT
- 4. Vcc

Block Diagram

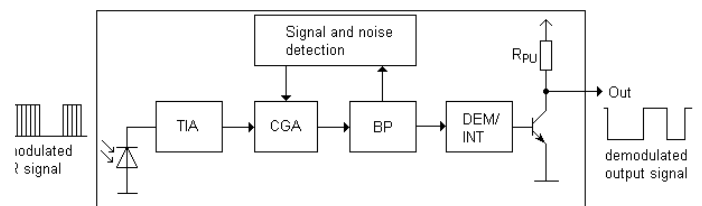

### Features

- High protection ability against EMI
- Available for various carrier frequencies
- min burst length: 12 cycles
- min gap length: 16 cycles
- Low operating voltage and low power consumption
- High immunity against ambient light
- High immunity against TFT backlight
- Long reception range
- High sensitivity
- Pb free and RoHS compliant
- Compliance with EU REACH
- Compliance Halogen Free (Br < 900 ppm, Cl < 900 ppm, Br+Cl < 1500 ppm)

### Descriptions

The device is miniature SMD type infrared receiver that has been developed and designed by utilizing the latest IC technology.

The PIN diode and preamplifier are assembled onto a lead frame and molded into an epoxy package which operates as an IR filter.

The demodulated output signal can directly be decoded by a microprocessor.

## Applications

- Light detecting portion of remote control
- AV instruments such as Audio, TV, VCR, CD, MD, etc
- Home appliances such as Air-conditioner, Fan, etc
- Other devices using IR remote control
- CATV set top boxes
- Multi-media Equipment

## Application Circuit

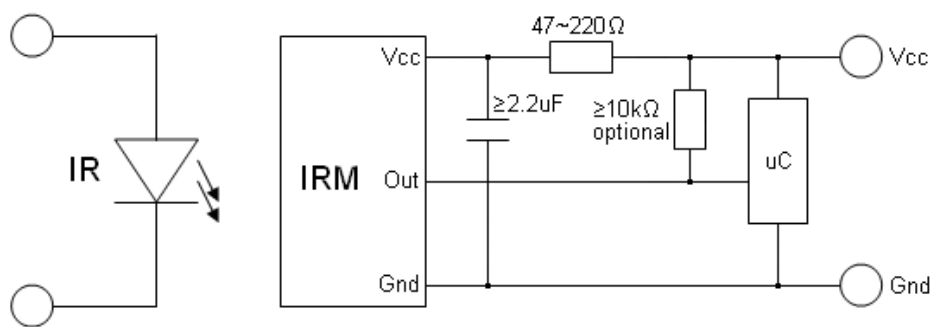

The RC filter must be connected as close as possible to Vcc and GND pins.

## Part number table

Model No.	Carrier Frequency
IRM-H638T/TR2	38 kHz

### Absolute Maximum Ratings ( $T_a=25^{\circ}\text{C}$ )<sup>\*1</sup>

Parameter	Symbol	Rating	Unit
Supply Voltage	Vs	6	V
Operating Temperature	Topr	-20 ~ +80	°C
Storage Temperature	Tstg	-40 ~ +85	°C
Soldering Temperature <sup>*2</sup>	Tsol	260	°C

<sup>\*1</sup> Stresses in excess of the absolute maximum ratings can cause permanent damage to the device. Functional operation of the device is not implied at these or any other conditions in excess of those given in the operational sections of this document. Exposure to absolute maximum ratings for extended periods of the time can adversely affect reliability.

<sup>\*2</sup> Soldering time  $\leq 5$  seconds

### Electro-Optical Characteristics ( $T_a=25^{\circ}\text{C}$ and $V_{cc}=3.0\text{V}$ )

Parameter	Symbol	MIN.	TYP.	MAX.	Unit	Condition
Current Consumption	Icc	---	0.4	0.7	mA	No signal input
Supply Voltage	Vs	2.7	---	5.5	V	
Peak Wavelength	$\lambda_p$	---	940	---	nm	
Reception Distance	$L_0$	8	---	---	m	See chapter 'Test method' <sup>*3</sup>
	$L_{45}$	5	---	---		
Half Angle (Horizontal)	$\Theta_h$	---	$\pm 45$	---	deg	
Half Angle (Vertical)	$\Theta_v$	---	$\pm 45$	---	deg	
High Level Pulse Width	$T_{WH}$	400	---	800	$\mu\text{s}$	Test signal according to figure 1 <sup>*4</sup>
Low Level Pulse Width	$T_{WL}$	400	---	800	$\mu\text{s}$	
High Level Output Voltage	$V_H$	$V_{cc}-0.4$	---	---	V	$I_{SOURCE} \leq 1\mu\text{A}$
Low Level Output Voltage	$V_L$	---	0.2	0.5	V	$I_{SINK} \leq 2\text{mA}$

<sup>\*3</sup> The ray receiving surface at a vertex and relation to the ray axis in the range of  $\theta=0^{\circ}$  and  $\theta=45^{\circ}$ .

<sup>\*4</sup> A range from 30cm to the arrival distance. Average value of 50 pulses.

## Test Method

The specified electro-optical characteristic is satisfied under the following Conditions:

1. Measurement environment  
A place without extreme light reflected
2. External light  
Ordinary white fluorescent lamps (Light source temperature 2856°K,  $E_e \leq 10\text{Lux}$ ) without high frequency modulation
3. Standard transmitter  
The test transmitter is calibrated by using the circuit shown in figure 2. The radiation intensity of the transmitter is adjusted until  $V_o=400\text{mVp-p}$ . Both, the test transmitter and the photo diode, have a peak wavelength of 940nm. The photo diode for calibration is PD438B ( $\lambda_p=940\text{nm}$ ,  $V_r=5\text{V}$ ).
4. Measuring system According to the measuring system shown in Fig.-3

Fig.-1 Transmitter Wave Form

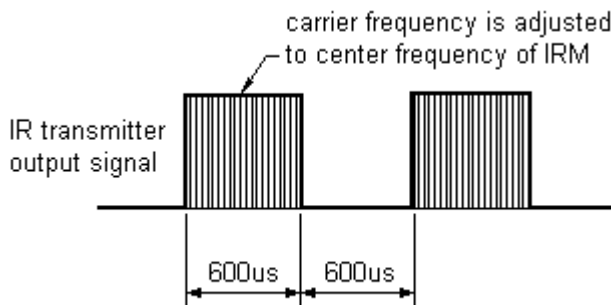

D.U.T output Pulse

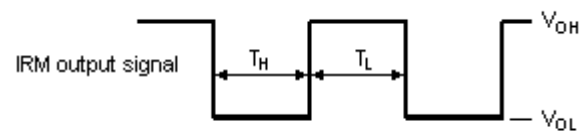

Fig.-2 Measuring Method

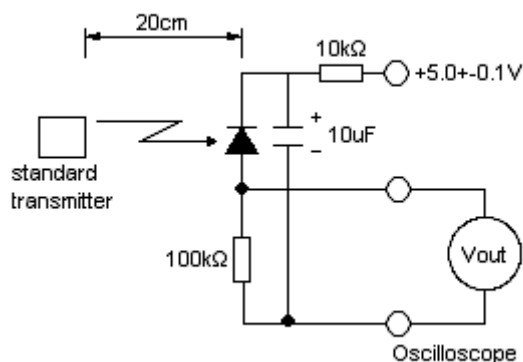
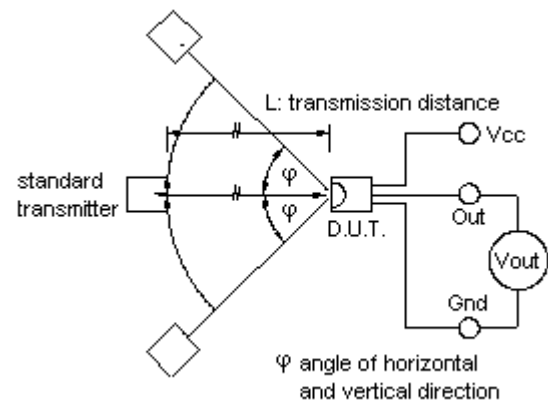
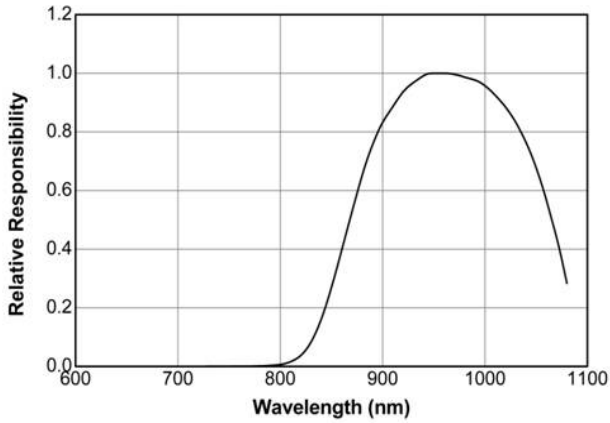

Fig.-3 Measuring System



**Typical Performance Curves**

**Fig.4 Relative Responsibility vs. Wavelength**



**Fig.-5 Relative Sensitivity vs. Horizontal Angle**

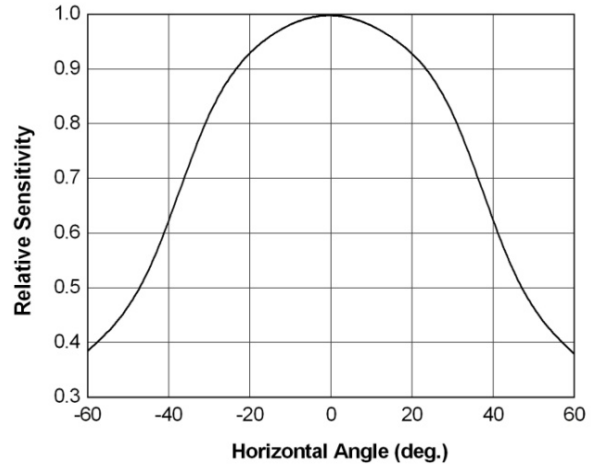

**Fig.6 Variation Output Pulse Width vs. Distance**

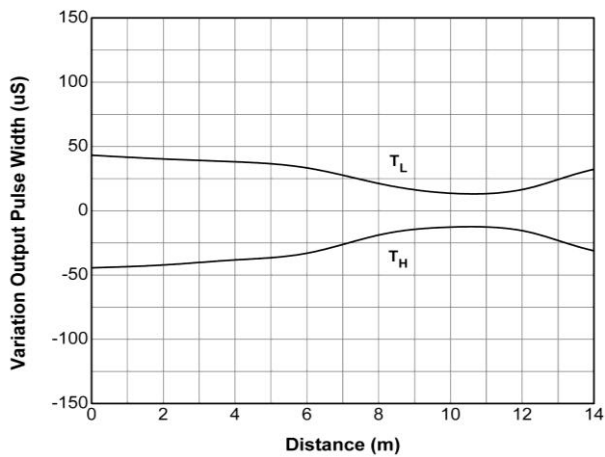

**Fig.-7 Relative Transmission Distance vs. Supply Voltage**

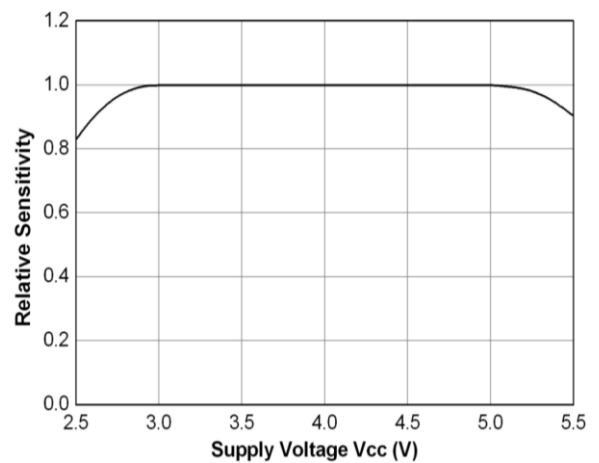

**Fig.-8 Relative Transmission Distance vs. Carrier Frequency**

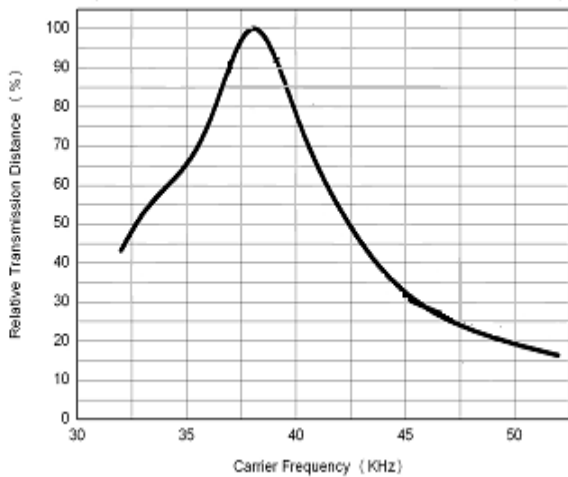

**Package Dimenstions**  
(Dimensions in mm)

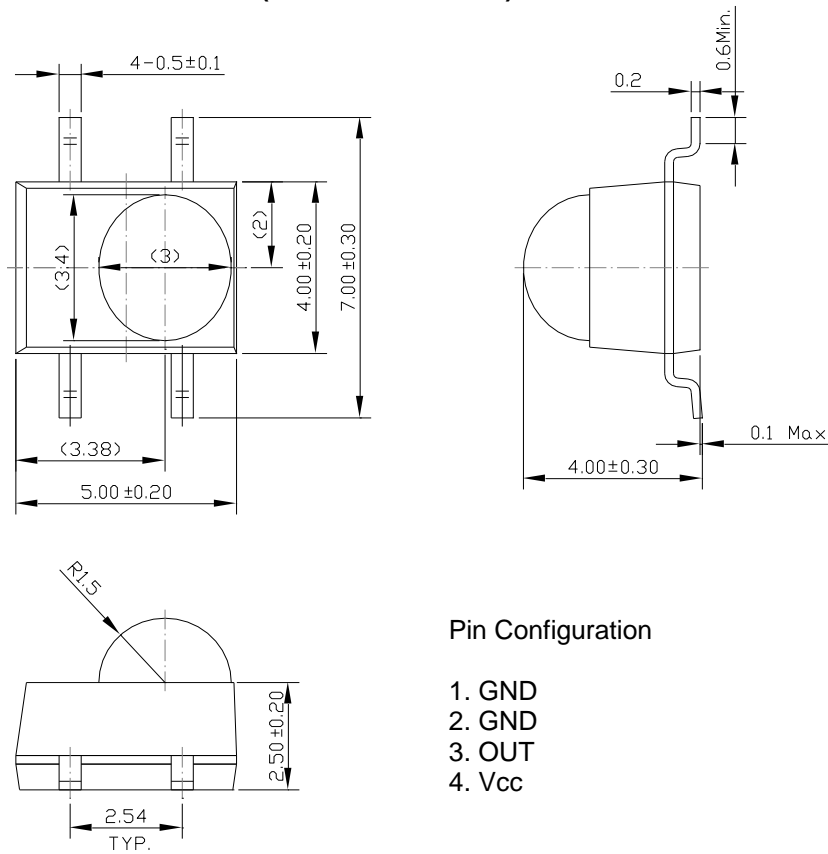

**Pin Configuration**

1. GND
2. GND
3. OUT
4. Vcc

**Note:**1. All dimensions are in millimeters.  
2. Tolerances unless otherwise mentioned  $\pm0.5\text{mm}$ .

**Recommend soldering patterns**

The following soldering patterns are recommended for reflow-soldering

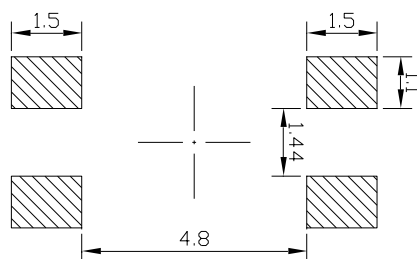

**Notice:**Suggested pad dimension is just for reference only.  
Please modify the pad dimension based on individual need.

### Code information

Protocol	Suitable	Protocol	Suitable
Matsushita	Yes	Sony 12 bit	Yes
NEC	Yes	Sony 15 bit	No
RC5	Yes	Sony 20 bit	No
RC6 <sup>1)</sup>	Yes	Sharp	Yes
Toshiba	Yes	Zenith	Yes
RCA	No	Continuous Code	No

1) RC6 is only compatible if the data low time is 25ms or more.

### Tape & Reel Packing Specifications

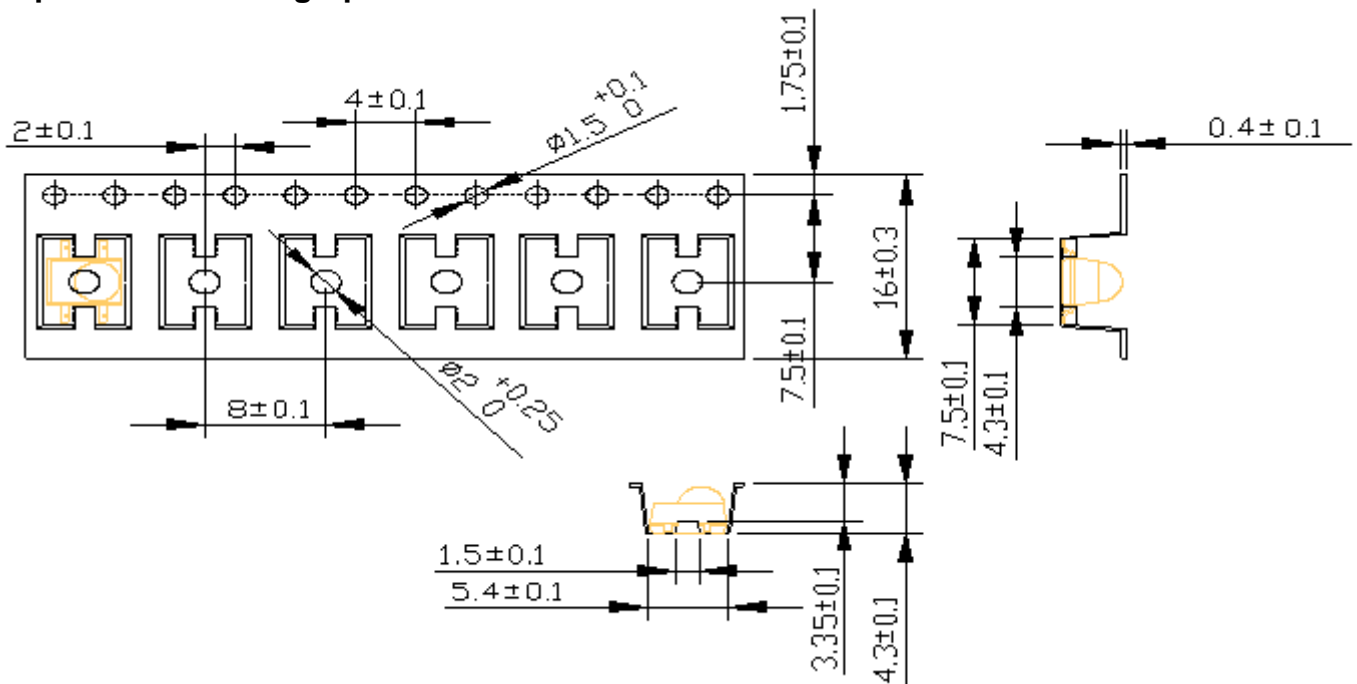

### Packing Quantity

1000 pcs / Reel  
5 Reels / Carton

## Recommended method of storage

The following are general recommendations for moisture sensitive level (MSL) 4 storage and use:

1. Do not open moisture proof bag before devices are ready to use.
2. Shelf life in sealed bag from the bag seal date: 12 months at 10°C~30°C and < 90% RH.
3. After opening the package, the devices must be stored at 10°C~30°C and ≤ 60%RH, and used within 72 hours (floor life).
4. If the moisture absorbent material (desiccant material) has faded or unopened bag has exceeded the shelf life or devices (out of bag) have exceeded the floor life, baking treatment is required.
5. If baking is required, refer to IPC/JEDEC J-STD-033 for bake procedure or recommend the following conditions: 96 hours at 60°C ± 5°C and < 5 % RH.



## ESD Precaution

Proper storage and handling procedures should be followed to prevent ESD damage to the devices especially when they are removed from the Anti-static bag. Electro-Static Sensitive Devices warning labels are on the packing.

## Solder Reflow Temperature Profile

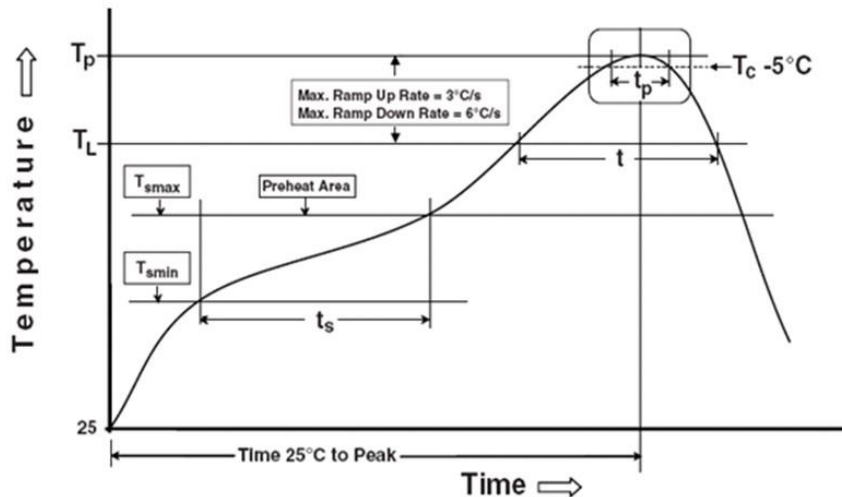

Note:

Reference: IPC/JEDEC J-STD-020D

### Preheat

Temperature min ( $T_{smin}$ )	150 °C
Temperature max ( $T_{smax}$ )	200°C
Time ( $T_{smin}$ to $T_{smax}$ ) ( $t_s$ )	60-120 seconds
Average ramp-up rate ( $T_{smax}$ to $T_p$ )	3 °C/second max

### Other

Liquidus Temperature ( $T_L$ )	217 °C
Time above Liquidus Temperature ( $t_L$ )	60-100 sec
Peak Temperature ( $T_p$ )	260°C
Time within 5 °C of Actual Peak Temperature: $T_p - 5^\circ\text{C}$	30 s
Ramp- Down Rate from Peak Temperature	6°C /second max.
Time 25°C to peak temperature	8 minutes max.
Reflow times	2 times

Note:

1. Reflow soldering should not be done more than two times.
2. When soldering, do not put stress on the IRM device during heating.
3. After soldering, do not warp the circuit board.

## **DISCLAIMER**

1. EVERLIGHT reserves the right(s) on the adjustment of product material mix for the specification.
2. The product meets EVERLIGHT published specification for a period of twelve (12) months from date of shipment.
3. The graphs shown in this datasheet are representing typical data only and do not show guaranteed values.
4. When using this product, please observe the absolute maximum ratings and the instructions for using outlined in these specification sheets. EVERLIGHT assumes no responsibility for any damage resulting from the use of the product which does not comply with the absolute maximum ratings and the instructions included in these specification sheets.
5. These specification sheets include materials protected under copyright of EVERLIGHT. Reproduction in any form is prohibited without obtaining EVERLIGHT's prior consent.
6. This product is not intended to be used for military, aircraft, automotive, medical, life sustaining or life saving applications or any other application which can result in human injury or death. Please contact authorized Everlight sales agent for special application request.

# Mouser Electronics

Authorized Distributor

Click to View Pricing, Inventory, Delivery & Lifecycle Information:

[Everlight:](#)

[IRM-H638T/TR2](#)